

TIMER

JSS48A	DIGITAL TIMER	JSS48B
--------	---------------	--------

- DIN-sized 48 × 48mm
- Time ranges (0.01s~99h99min)



CHARACTERISTICS

Time ranges:

Select switch:	h	m	s
Time ranges:	1m—99h99m	1s—99m99s	0.01s—99.99s

Supply voltage : AC220V (50/60Hz) Control output: AC 250V 3A (Resistive) (JSS48A)

AC 250V 5A (Resistive) (JSS48B)

Operating voltage range $U_e 85\% \sim 110\%$

Contact: JSS48A:2c

Setting error : 0.01%+0.05s

JSS48B:1C

Ambient Operating: -10 to 55

Panel cutout: 45 × 45 mm

temperature :

Power consumption: 3VA

Weight; 0.3kg

Display: Up/Down

OPERATION MODE

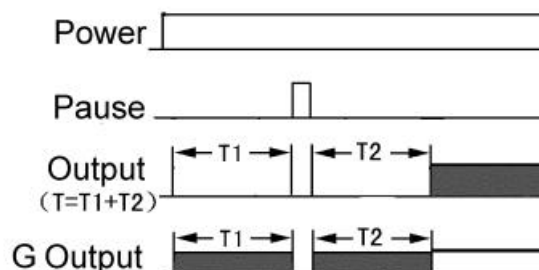

DIMENSIONS

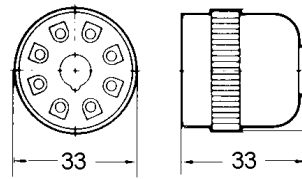
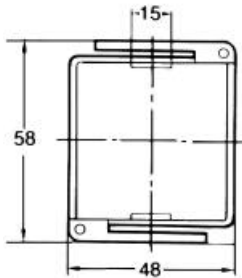
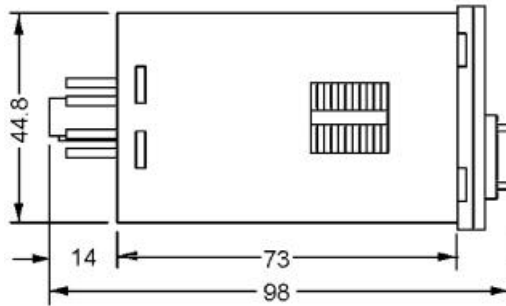
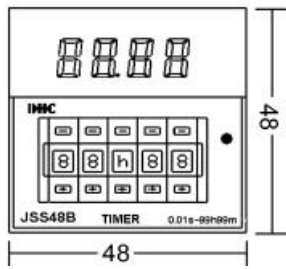

CONNECTIONS

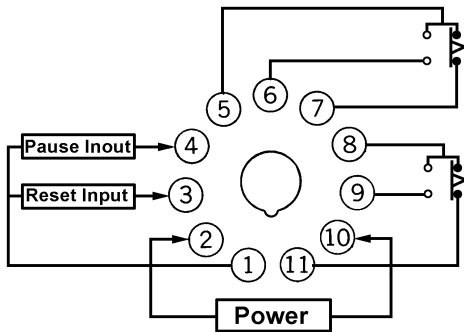

JSS48A

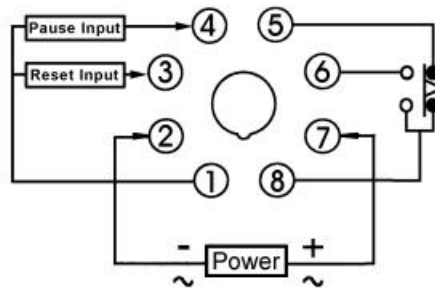

JSS48B